

Customer
 Date 20.2.2024.
 Project
 Reference
 Quotation No



Stefani S.p.A.

Via del Lavoro, 9
 Castegnero (VI) - ITALY
 Tel. +39 0444 639 999
 Fax. +39 0444 638 240

EVAPORATOR

Model 1 x BOREA H 44-4 D 6,5 E 4S

Capacity	32,2 kW	Refrigerant	R404A
Air Inlet Temperature	0,0 °C	Evaporating Temperature	Dew -10,0 °C
Air Outlet Temperature	-3,7 °C	Superheating	5 K
Relative Humidity In	79 %	Condensing Temp	Dew 40,0 °C
Relative Humidity Out	95 %	Subcooling	0 K
Q.ty of condensed water	7,5 kg/h		
Altitude	0 m		
Air Flow	20450 m ³ /h	RPM rate	100 %
Air throw	24,7 m	Fan Speed	1310 1/min
Number fans	4	Noise Power Level	79 dB(A)
Fan Diameter	450 mm	Noise Pressure Level ISO 3744	53 dB(A) at 5 m
Voltage	230 V	Power consumption	1960 W
Frequency	50 Hz	Nominal Power	1960 W
Power Supply	Single Phase	Nominal Current (*)	9,44 A
Available Static Pressure	0 Pa		
Surface	78,2 m ²	Tubes	Copper
Internal Volume	24,3 dm ³	Fins	Aluminium
Fin Spacing	6,5 mm	Casing	Aluminium Painted / Galvanized Steel Painted
Weight	128 kg	Length	2710 mm
Connections IN	28 mm	Height	750 mm
Connections OUT	42 mm (**)	Width	535 mm
		PS	30 bar
Defrosting	Electric	1x3+5x3=15 kW	

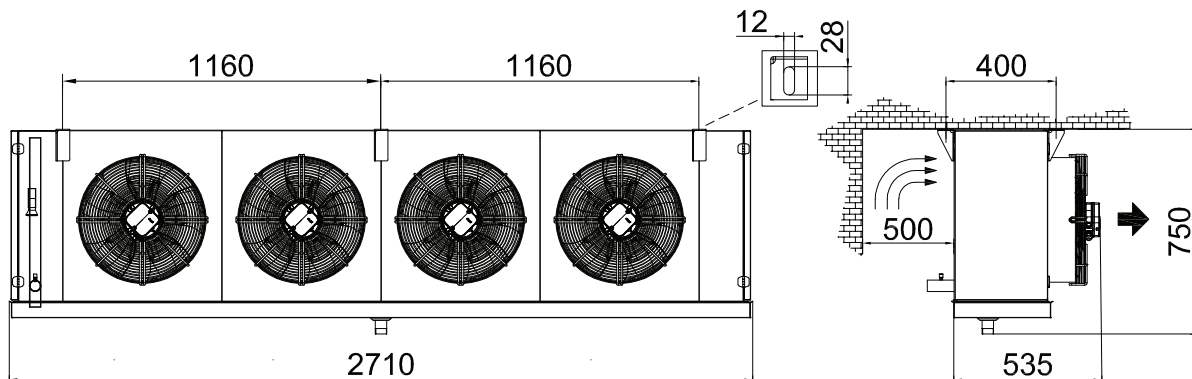

(*) JERP COMPLIANT Current consumption can be different due to the air temperature

NOTE

(**) Warning: connection velocity besides suggested limits!

MasterUnits 2016 - v. 230130
 08B15642H0B29AF5D000000008A666EFCF9